



Newsletter

Heber Primary School

Heber Road, London, SE22 9LA

t: 020 8693 2075 | F: 020 8299 0239
w: heberprimaryschool.com
e: adminoffice@heber.southwark.sch.uk

twitter : @heberschool

BBC Micro:bits

Issue number: 12 8th December 2023

As part of the BBC's 'micro:bit- the next gen' campaign, we have been lucky enough to receive a set of 30 BBC micro:bits!

The BBC micro:bit is an award-winning programmable device that allows students to get hands-on with coding and digital making. Alongside our Discovery Coding lessons, children at Heber will be able to use the micro:bits to recognise the power of technology and programming in the real world.

The lucky children in 6A were the first class to get their hands on the new micro:bits and tested out a number of the features, writing their block coding using the micro:bit makecode website, then downloading their work to the micro:bit hardware.

New micro:bit with sound

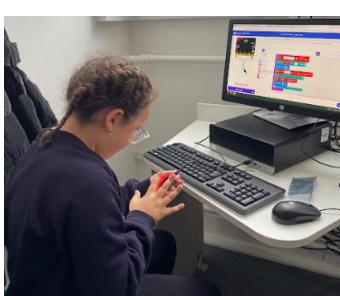
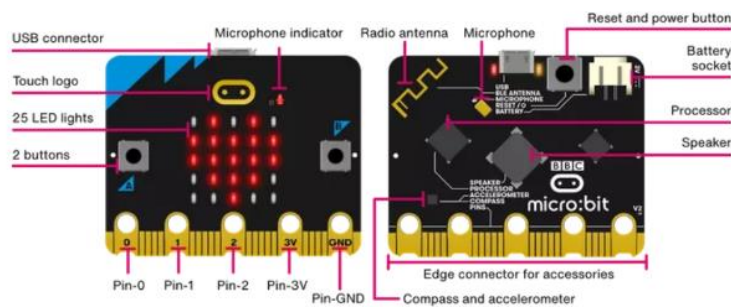

Programming a micro:bit to play Rock, Paper, Scissors!



Taking coding a step further and experimenting with JavaScript .



Programming micro:bits to display messages and emojis.



Using a micro:bit's radio transmitter to send messages to others.

If children would like to try out some micro:bit programming at home, they can access the makecode website using this link: <https://makecode.microbit.org/> . The website features lots of simple tutorials for children of all ages, and a micro:bit simulator so that they execute their code and see it working!



Children can login by clicking this logo in the top right corner of the page, selecting 'Login with Google' and using their school Google logins (username.210@heberprimaryschool.com).



Newsletter

Heber Primary School

Heber Road, London, SE22 9LA

t: 020 8693 2075 | F: 020 8299 0239
w: heberprimaryschool.com
e: adminoffice@heber.southwark.sch.uk

twitter : @heberschool



School Council Fundraising for New Hope, Cambodia

This year, our school council has decided to raise money for [New Hope School](#) in Cambodia after being inspired by Miss Rosenberg's recent visit to the school. Cambodia was badly affected by the Covid-19 pandemic as many people were unable to work and as a consequence sadly many children effectively went missing from education. New Hope School provides free education, health care and community and crisis care support for families living in Mondul Bei Village, Siem Reap. We are excited to make some strong links with the children and staff at the school this year.





At the School Fete on Saturday, the School Council are going to be raising funds by running a Make Your Own Christmas card stall. This will be a great chill out zone for children (and a great way to make a loving card for Mum, Dad, Grandparents etc!) There will also be a very tricky 'Guess the Teacher' competition by looking at very blurred photos of teachers in Santa Hats and beards! (With the correct entries entered into a prize raffle!) We are asking for suggested donations of £1 to join in each activity. So please bring £1 coins with you! (Larger donations are equally much appreciated!)

Winning House is Revealed

What a term it has been! All the children have been working so hard earning house points but there can only be one winner at that house is.... MYCROFT!

As a reward Mycroft can come to school on Wednesday 13th December in their own clothes, representing their house colour (blue) and will be having a mini Christmas Disco. Well done Mycroft! The race begins again in January.



House Points	Rigal	Mycroft	Valdez	Ndume
				
This Week	469	464	463	461
Total	5169	5171	5161	5167

Christmas lunch and Festive Attire

A free Christmas lunch will be available for all children on Thursday 14th December. Children are welcome to wear festive attire or their own clothes on the day.

Please feel free to decorate an item of clothing that you already have instead of purchasing one especially for the day.



Newsletter

Heber Primary School

Heber Road, London, SE22 9LA

t: 020 8693 2075 | F: 020 8299 0239
w: heberprimaryschool.com
e: adminoffice@heber.southwark.sch.uk

twitter : @heberschool

This Week in Art

Year 4 have impressed Miss Coulson immensely with their final self-portraits, their drawing skills have vastly improved over this term.

Years 1 and 2 got festive and made some baubles to decorate the Art room.

Year 6 finally completed part of their Mayan inspired Sculptures, which are now up on display in the Art room. Temples to follow!

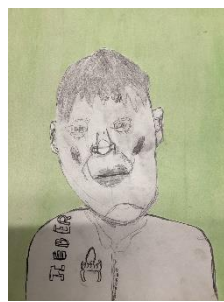
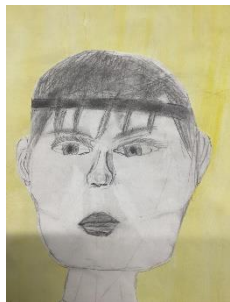

Get Rid of and Donate

For families in need, there will be an Open House at St Faith's this year on Monday 11th December. Get Rid of and Donate will then be closed, reopening in the new year on Monday 15th January.

Academic Excellence Awards

This week in our Merit Assembly we celebrated the successes of a child from each class, who excelled in their learning and produced some outstanding work. Well done to the following children:

RH	Alonya	RP	Thea
1C	Zac	1V	Toby
2H	Florence	2JP	Isabel
3N	Abdullah	3W	Kaya
4LC	Monty	4S	Betina
5G	Haroon	5K	Saara
6A	Taliyah	6F	Lola

Stars of the Week

Congratulations to the following children who were chosen as the Star of the Week for demonstrating our school values this week:

RH	Chloe	RP	Sebbie
1C	Kiki	1V	Ayla
2H	Noa	2JP	Medina
3N	Dylan	3W	Malachi
4LC	Ian	4S	Sofia
5G	DW	5K	Warith
6A	Luna	6F	Sajed



Newsletter

Heber Primary School

Heber Road, London, SE22 9LA

t: 020 8693 2075 | F: 020 8299 0239
w: heberprimaryschool.com
e: adminoffice@heber.southwark.sch.uk

twitter : @heberschool

December

Saturday 9 th (12:00pm – 4:00pm)	Heber P&F Christmas Fair
Monday 11 th	Year 5 watching The Snow Queen at Alleyns
Tuesday 12 th (9:30am and 2:30pm)	Key Stage 1 Christmas performance
Wednesday 13 th (9:10am)	Monster Phonics workshop for parents/carers – All years
Wednesday 13 th (2:30pm)	Nursery Christmas concert
Thursday 14 th	School Christmas lunch and festive attire
Thursday 14 th (3:30pm)	Years 5 and 6 Carol Concert
Tuesday 19 th	Reception – Rapunzel at Theatre Peckham
Tuesday 19 th (9:30am and 2:30pm)	Years 3 and 4 Christmas performance
Wednesday 20 th	Last day of term – Children finish at 2:00pm Class Christmas Parties – Children can wear own clothes
Thursday 21 st – Monday 8 th January School Holiday	

January

Tuesday 9 th	Children return to school
Tuesday 16 th	Perform drama workshops
Thursday 18 th and 19 th	Years 1&2 road safety pedestrian training Year 1 Unicorn Theatre (1C 18 th / 1V 19 th)
Thursday 25 th (9:15am)	Maths workshop for parents/carers – Years 5 and 6
Friday 26 th	Get Rid of and Donate collection
Monday 29 th	Year 6 visiting the Horniman Museum
Tuesday 30 th	3N – Guildhall Art Gallery and London's Roman Ampitheatre
Tuesday 30 th (9:15am)	Class Assembly – 1V



Newsletter

Heber Primary School

Heber Road, London, SE22 9LA

t: 020 8693 2075 | F: 020 8299 0239
w: heberprimaryschool.com
e: adminoffice@heber.southwark.sch.uk

twitter : @heberschool

The citizens of Cambodia are in desperate need of help. Children do not have a very good education, if any at all. But New Hope Cambodia can change this. This is how you can help:

- 8 dollars for extra food (like milk, fruit and eggs) for 1 malnourished kid per week
- 10 dollars for 2 sets of school uniforms for 1 kid per year
- 15 dollars for school materials - bag, books, pen etc.
- 25 dollars for 1 pack of good package
- 40 dollars for the cost of education for 1 kid per month
- 50 dollars for 1 bike
- 100 dollars for small renovations of school infrastructure

HELP THE

Come to the School Council! We will have your ideas for how to help Cambodia! We will have your ideas for how to help Cambodia!

School Council
raise money for

Please help. Cambodia needs it.

NEW HOPE CAMBODIA

All donations go to NHC.



Newsletter

Heber Primary School

Heber Road, London, SE22 9LA

t: 020 8693 2075 | F: 020 8299 0239
w: heberprimaryschool.com
e: adminoffice@heber.southwark.sch.uk

twitter : @heberschool

COME TO HEBER PRIMARY'S CHRISTMAS FAIR

SATURDAY, 9TH DEC, 12-4PM, HEBER ROAD

COME ALONG FOR:
FOOD & DRINKS
GAMES & CRAFTS
BOUNCY CASTLE
SANTA'S GROTTO
FACEPAINTING
RAFFLE
SHOPPING
& BAGS OF HOLIDAY SPIRIT
IN SUPPORT OF OUR SCHOOL.

WE HOPE TO SEE YOU THERE!



BOOK YOUR GROTTO SLOT AT [TICKETSOURCE.CO.UK/HEBERPANDF](https://ticketsource.co.uk/heberpandf)

Because we want to include every Heber child at the fair, we've created a code which allows any families who need it, to book the grotto for free. Enter the code FREEGROTTO at checkout on ticketsource.co.uk/pandf. Look forward to seeing you there!



Newsletter

Heber Primary School

Heber Road, London, SE22 9LA

t: 020 8693 2075 | F: 020 8299 0239
w: heberprimaryschool.com
e: adminoffice@heber.southwark.sch.uk

twitter : @heberschool



SENsational Open Day!

Come along to find out more about SENsational Play sessions for children with additional needs and disabilities!



- Find out where sessions take place
- Meet the staff
- Find out how you can access if you have a child up to age 11 (or how to refer)
- See how sessions are run
- Check out the resources available
- FREE goodie bags to take away!!

Tuesday 12th December, 11am - 2pm
Ann Bernadt Children & Family Centre,
Chandler Way, SE15 6DT

Families and professionals welcome
Yummy light refreshments provided!

For more information contact
childrenscentre@ivydale.southwark.sch.uk



Southwark Children and Family Centres

